

GB 902-903

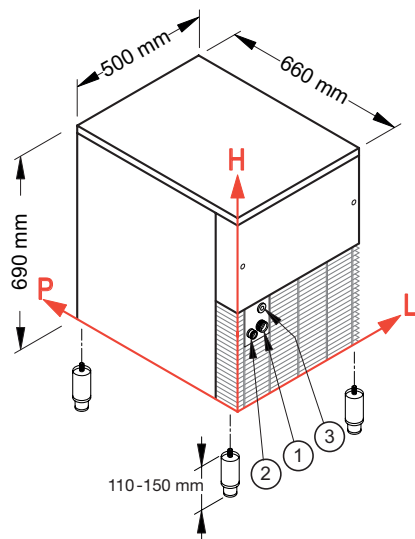

GB 902

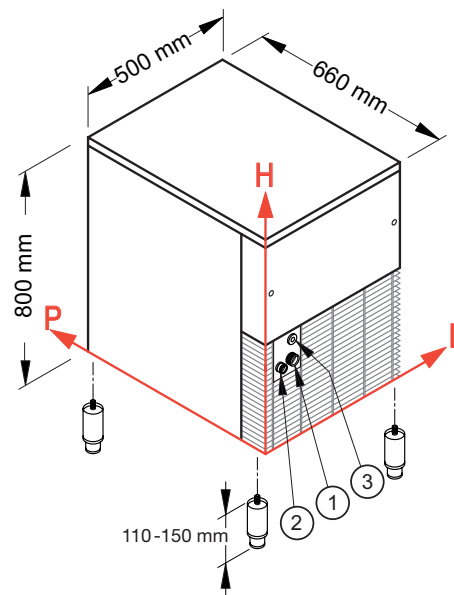

GB 903

CONNECTIONS / CONNESSIONI	GB 902			GB 903		
	L	H	Ø	L	H	Ø
① Water inlet / Ingresso acqua	99	158	3/4"	99	158	3/4"
② Water outlet / Scarico acqua	48	151	24 mm	48	151	24 mm
③ Electrical connection / Connessione elettrica	87	230	-	87	230	-

TECHNICAL INFORMATION / DATI TECNICI	GB 902	GB 903
Production in 24 h, till / Produzione in 24 h, sino a	90 kg	90 kg
Storage capacity / Capacità contenitore	20 kg	30 kg
Cooling system / Condensazione	A - W	A - W
Refrigerant / Refrigerante	R404A	R404A
Standard voltage / Voltaggio standard	220-240 V ~ 50 Hz	220-240 V ~ 50 Hz
Electrical consumption / Consumo elettrico	550 W	550 W
Fuse / Fusibile	10 A	10 A
Water consumption (l/kg) / Consumo acqua (l/kg)	A 1 W 6,3	A 1 W 6,3
Sizes (WxDxH) / Dimensioni [LxPxH]	500x660x690 mm	500x660x800 mm
Sizes with packing (WxDxH) / Dimensioni con imballo [LxPxH]	550x720x880 mm	550x720x990 mm
Weight (net/gross) / Peso [netto/lordo]	59/67 kg	67/76 kg

Finishing 18/8 stainless steel, scotch brite / Finitura acciaio inox 18/8, scotch brite

INSTALLATION CONDITIONS / CONDIZIONI D'INSTALLAZIONE	Min / Max
Installation / Installazione	indoor / interna
Ambient temperature / Temperatura ambiente	+10 / +43 °C
Water temperature / Temperatura acqua	+3 / +32 °C
Voltage / Voltaggio	± 10%
Water inlet pressure / Pressione dell'acqua in ingresso	1bar (14psi) / 6bar (84psi)

CONDITIONS / CONDIZIONI	
Ambient temperature / Temperatura ambiente	+21°C
Water temperature / Temperatura acqua	+15°C
Electrical consumption at +43°C (standard voltage) / Consumo elettrico a +43°C (voltaggio standard)	

GB 902-903



Automatic granular ice flakers.

Compact granular ice for various different uses in bars, restaurants, fish-shops, chemical and pharmaceutical industries.

Produttori automatici di ghiaccio a scaglie granulari.

Ghiaccio a granuli compatti per i diversi impieghi in bar, ristoranti, pescherie, industria chimica e farmaceutica.



GB 902



GB 903

